



User Guide



IMPORTANT:



Read carefully the SkyTrak Safety and Product Information Guide before setup or use of the SkyTrak™ system. Failure to read and follow the Safety and Product Information Guide may cause serious injury or death.

The SkyTrak system specifications and functionality are constantly evolving, and we may update or change the SkyTrak system in whole or in part, without notice to you. Such updates may be required for you to use new functionality, access new courses or features, or continue to access and use existing courses and features. The courses and features available for use on the SkyTrak system change from time to time, and not all courses or features previously offered will be available. Some features require an annual subscription.

The software in the SkyTrak system is licensed and not sold to you, and is subject to the End User License Agreement set forth in the SkyTrak Safety and Product Information Guide.

Hardware compatibility:

SkyTrak is compatible with iPad®, Android® and PC devices. For specific info go to: <http://www.skytrakgolf.com/about-skytrak/specifications>

Table of Contents

Product Overview	4
Charging Your SkyTrak	5
Getting Started.....	5
Powering On/Off	8
Setting Up Your Space for SkyTrak.....	8
Minimum Unobstructed Area Dimensions	9
Placement of Golf Ball	10
Helpful Tips & Care Instructions	11
LED Color Code Chart.....	12
Troubleshooting.....	13
Top Tips for Use	14
Registration Process.....	15
Upgrading SkyTrak Membership Level	18
Network Connection Guide	19
Software Guide	22
Video Connection Guide	30

Product Overview

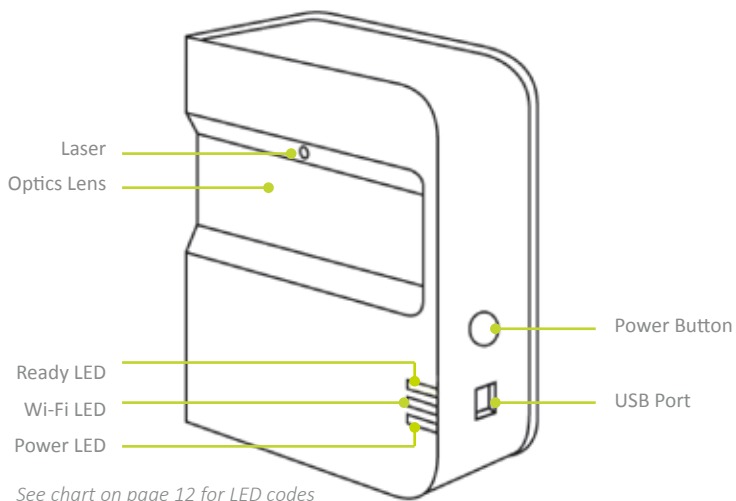

What's in the Box



SkyTrak® Personal
Launch Monitor

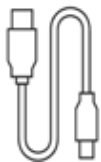

USB Cable



Quick Start and Product &
Safety Information Guides



Wall Charger

Charging Your SkyTrak

SkyTrak contains a Lithium-polymer rechargeable battery that can operate up to 5 hours on a full charge.

IMPORTANT: The SkyTrak must be charged for a minimum of 6 hours before use.

NOTE: It is advisable to ensure your SkyTrak unit always has a good charge. If the SkyTrak battery is completely drained it can reduce the life of the battery. When a low battery indicator shows in the SkyTrak App - charge the unit.

NOTE: The SkyTrak may be connected to PC via full USB to Micro USB cable supplied. This allows the PC to run a constant charge to the unit, for all day use.

Let's Get Started!

Setting up your SkyTrak for the first time is a simple 3-step process:

1

Download the SkyTrak App

Find the SkyTrak software in the Apple® App StoreSM or download the SkyTrak PC application on www.skytrakgolf.com

2

Register Your SkyTrak

Launch the SkyTrak software on your mobile device or PC and follow the instructions in the SkyTrak application.*

If you already have a SkyGolf / SkyCaddie Account – Log in with your username and password.

If you do not already have an account, select the “Create Account” option to create a SkyTrak online account.

Next, select “Register” to register your SkyTrak. Your SkyTrak’s unique serial number will display and it will be registered with SkyTrak

** Your SkyTrak must be registered within 30 days of purchase. SkyTrak comes with basic functionality in-the-box and may come with some trial features, enabling you to start playing immediately. Advanced features are available with a SkyTrak annual subscription plan, which can be purchased at www.skytrakgolf.com.*

SETUP TIP: Once SkyTrak has been successfully configured and connected with the software on your mobile device or PC, all three LEDs will turn green and you will see a red laser dot projected onto your hitting surface.

3

a. Pair Skytrak With Your Mobile Device

You can pair SkyTrak with your mobile in two ways:

- Via a direct Wi-Fi connection OR
- Through your home network

Direct Wi-Fi Connection

Follow the instructions in the SkyTrak software application to pair your mobile device directly to SkyTrak via its Wi-Fi signal. Your mobile device will NOT have an internet connection when connected in this manner.



Network Connection (recommended)

SkyTrak can use your wireless (Wi-Fi) home network to pair with your mobile device by connecting to your wireless network router, just like your computer and mobile devices do. SkyTrak will communicate with the software on your mobile device through your router. Plus, you will retain access to the internet on your mobile device. (See *Network Connection Guide, pg. 18*)



b. Pair SkyTrak with your PC

You can pair SkyTrak with your PC in the following ways

Via a direct Wi-Fi connection OR Via a direct USB cable connection OR Through your home network

Direct Wi-Fi Connection on PC

Click on the Wi-Fi signal icon on your PC and select SkyTrak from the drop down menu, click Connect.



USB Cable Connection

Connect the micro USB cable to the SkyTrak device and a USB port on your PC

Network Connection – SkyTrak can use your wireless (Wi-Fi) home network to pair with your PC by connecting to your wireless network router, just like your computer and mobile devices do. SkyTrak will communicate with the software on your PC through your router. Plus, you will retain access to the internet on your PC. (See *Network Connection Guide, pg. 19*) If you are using the USB cable connection, remain connected to your wireless home network.



SETUP TIP: Follow the Wi-Fi configuration steps in the SkyTrak software to select your desired connection mode. To make changes to your connection, access the Connection Wizard near the bottom of the main dashboard of the SkyTrak software at any time.

Powering On/Off

1. To turn on SkyTrak, press the POWER button.
2. The Power LED (bottom) will turn **GREEN** and you can start connecting SkyTrak to your iPad or PC.
3. To turn off SkyTrak, press the Power button again.

Setting Up Your Space for SkyTrak

To reduce the risk of injury or property damage, it is recommended that the SkyTrak system be set up using the guidelines below. Please ensure that you have created enough space around you to safely play with SkyTrak and that you heed all applicable safety precautions at all times.

SETUP TIP: For optimum performance, it is recommended that you use a hitting mat for both indoor and outdoor use.

Minimum Unobstructed Area Dimensions

Ceiling height: Safe ceiling height varies and depends on your physical height and the length of your club.

Length: 10 feet (3,35m)

Width: 10 feet (3,35m)

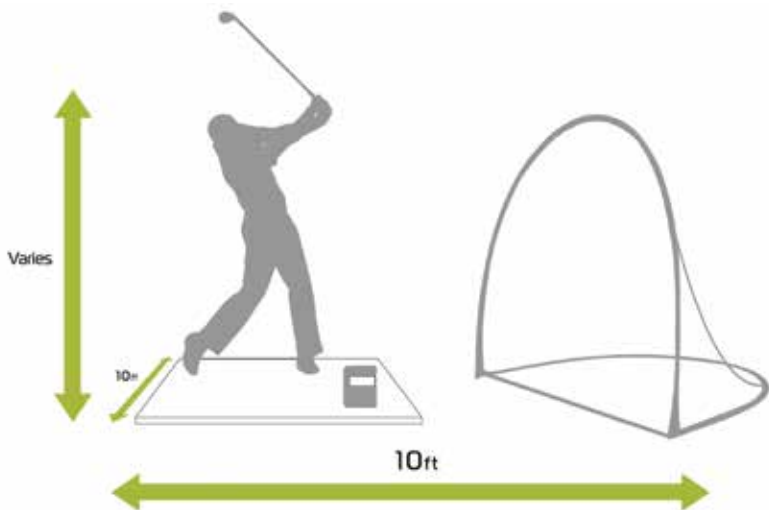

CAUTION: Always use a safety net and a hitting mat specifically designed for golf if the hitting area or the ball flight area is restricted such as indoors or in the back yard of a residence.

Placement of Your Golf Ball

Make sure SkyTrak is raised level with the hitting surface.

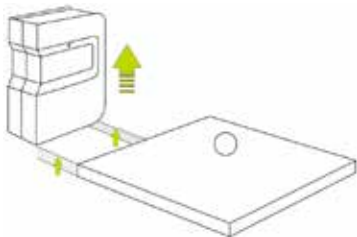

Once SkyTrak is properly connected to the app on your mobile device, it will display a red laser dot on your hitting surface. Place a clean, white golf ball on the red dot.

*Place ball on red dot
- or -
Place base of tee on
red dot*

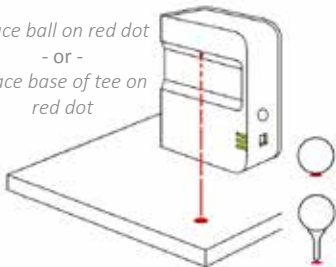

Place SkyTrak parallel to your intended line of play. Depending on your set up, this may mean your target is not the center of the net.

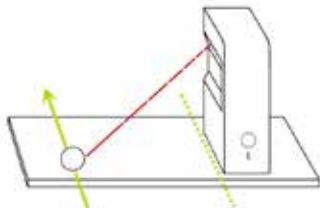

The intended target line should be parallel to the SkyTrak for accurate shot simulation. Recommend using alignment sticks to check the target line. We suggest marking a line of the target in the ground or the net to ensure you are aligned to the target correctly.

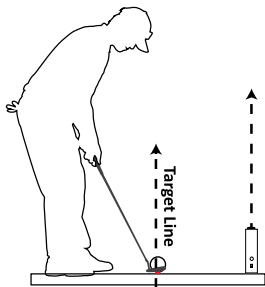

Use of alignment sticks/ golf clubs increases the accuracy of intended line of play.

TIP

Being too far above or below the hitting surface can affect consistent shot capture and ball flight data. Recommended laser distance 11 ½" to 12 ½"





















SETUP TIP: For optimum spin results, place the ball on the laser dot with some kind of marking on the golf ball, such as its brand logo, facing toward SkyTrak's lens prior to hitting.

Helpful Tips & Care Instructions

- SkyTrak uses advanced optics that are located behind its lens. Scratches and dust or other issues that impact the lens quality may interfere with SkyTrak's operation. Keeping the lens clean and scratch-free will ensure the measurement accuracy and longevity of your SkyTrak system.
- Use a clean, damp cotton cloth to clean the lens in a single wipe. **Do not use any chemicals to clean the lens.**
- Carrying cases to keep your SkyTrak protected and other accessories are available for purchase at www.skytrakgolf.com
- Never disconnect or turn off your SkyTrak while it is syncing. Wait until it is finished communicating before you disconnect it, power it off, or power off your mobile device.
- Don't expose your SkyTrak to extreme temperatures. Hot or cold conditions may affect performance.
- Don't allow your SkyTrak to get wet.
- Don't drop your SkyTrak, or hit your SkyTrak with your golf club or golf ball.
- Compatibility of your SkyTrak device with mobile devices, like tablet computers, varies by mobile device and its operating system and display capabilities, which change often and are outside the control of SkyTrak. Not all mobile devices are compatible with your SkyTrak device. To view a list of currently compatible devices, go to www.skytrakgolf.com
- **Fully charge the battery prior to playing with your SkyTrak.**

LED Color Code Chart

Use this chart to identify or troubleshoot SkyTrak's various operational modes.

Power LED	Wi-Fi LED	Ready LED	Description
			Battery is low and SkyTrak is about to turn itself off. Please charge your SkyTrak as soon as possible.
			SkyTrak is in Direct Connect Mode, waiting for a connection with the SkyTrak Application on your tablet.
			SkyTrak is in Network Mode and it is attempting to locate and connect to a known Wi-Fi network.
			SkyTrak is in Network Mode and it has located a known Wi-Fi network. It is attempting to connect to that network.
			SkyTrak is in Network Mode and it is connected to a known network. It is waiting for a connection with the software on your tablet.
			SkyTrak is connected to the Application. If the Ready LED is not turning green quickly, please check to see if SkyTrak is tilted instead of being level.
			SkyTrak is ready for your next shot.
			SkyTrak is charging.
			SkyTrak is charging, but the power of the charger is not adequate, it may take a long time for your SkyTrak to charge.

Troubleshooting

Problem	Solution
When charging, 'Power' LED does not come on (AMBER)	Press and hold the Power button for 5 seconds. Make sure the USB cable has power. Try other ports on your computer or use a compatible USB wall charger. SkyTrak should be turned OFF to charge.
All 3 LED's turn red and unit turns off after 15 seconds	Battery is low. Connect the USB cable and charge the unit. The Power LED will turn off when SkyTrak is fully charged and ready to go.
'Wi-Fi' LED is not turning green	First, ensure that your SkyTrak is connected to the Wi-Fi network. Then start the SkyTrak software on your iPad and allow it to load. When the application is open, SkyTrak's LEDs will show whether it successfully connected.
Wi-Fi and Power LEDs are green, but 'Ready' (top) LED is red	Your SkyTrak may have been triggered by a waggle or other club movement. If you'll wait a few seconds, it should turn green again. If it still doesn't turn green, you should check your Wi-Fi connection and restart the application on your iPad.
Results seem inaccurate	Be sure to position the ball correctly on the red dot and make sure the unit sits level with the hitting surface. If using a tee, make sure the base of the tee is on the red dot.

Should this Trouble Shooting Guide not answer your question, please refer to the Frequently Asked Questions at www.skytrakgolf.com.

Top Tips for Use

1. We recommend hitting off a mat designed specifically for golf. Place the ball or the base of the tee on the red dot projected by the laser. If a mat is not available, we suggest hitting off a tee from the grass. Irons and wedges hit directly off the grass create dirt and grass particles from the divots that can make for inconsistent shot capture.
2. SkyTrak performs well in overhead sun. Avoid direct sunlight into the system during use. Direct sun into the optic lens of SkyTrak can create problems for consistent shot capture. If available, please hit from a covered area .
3. Use a clean, white ball with a logo or a marked line. Set the ball up with the logo or line facing SkyTrak for better spin readings, whether indoors or outside.
4. Prior to an outdoor demo, pick out a target on the range and align SkyTrak so that it sits parallel to the intended target line.

Registration Process

Your new SkyTrak includes a 30-day trial in order to play with your SkyTrak right out of the box. The complimentary trial period gives access to practice sessions and basic settings. After the trial period you will need to complete the registration process and sign up for a SkyTrak membership plan that best suits your needs.

1. To register a new SkyTrak, you will first need to download the SkyTrak app to your mobile device by searching for “SkyTrak” in your device’s app store or download the SkyTrak PC application from www.skytrakgolf.com.
2. Open the SkyTrak app and sign in with your SkyGolf account username and password. If you do not already have a SkyGolf account, choose the “Create Account” option.
3. Your SkyTrak will need to be in Network Mode in order to complete the registration. For instructions, please see the network connection guide.
4. Select the profile menu from the top right corner.



5. Select "About."



6. Select "Register Device" button.



7. Select "Yes, Register My Device."



8. After receiving the message that your device is successfully registered, select done.
9. Your SkyTrak is now registered to your SkyGolf account and will receive basic features.



Upgrading SkyTrak Membership Level

To access premium features such as challenges and full course play with our simulator partners, you have the option to upgrade your membership level. For a full overview of membership options, please see <https://shop.skygolf.com/c-208-skytrak-plans.aspx>

1. After purchasing an upgraded membership, you will receive an email from SkyGolf to activate your membership.
2. Select the “Activate” button in the email to finalize your membership upgrade.

IMPROTANT: Your SkyTrak must be updated with membership information so that you can begin playing with your new software.

To begin using you the SkyTrak with upgrade plans such as Game Improvement or Play & Improve

1. Connect your SkyTrak via network mode and login to the SkyTrak App with your username and password.

OR

2. Connect the mobile device or PC to your WIFI network, login to the SkyTrak app with your username and password, and wait until they see the “Data Synced” message at the top. Note this does not require the SkyTrak to be paired to the mobile device or PC.

Network Connection Guide

SkyTrak can be connected to your iPad or PC several ways:

Via a direct Wi-Fi Connection, through your home network/wireless router or USB connection (PC Only).

The **Direct Wi-Fi Connection** should be used if you do not have access to a reliable Wi-Fi network (such as on the driving range). When using a Direct Connection, your mobile device or PC connects directly to the SkyTrak's Wi-Fi, and thus, does not have access to the internet.



The **Network Connection via network/wireless router** should be used when you have access to a reliable Wi-Fi network. This connection mode is required for certain features/simulator options where an internet connection is needed. When using a Network Connection, your mobile device or PC uses the wireless router as a bridge to connect the SkyTrak unit to your mobile device or PC so the mobile device or PC can maintain a connection to the internet.



USB Cable Connection

Connect the micro USB cable to the SkyTrak device and a USB port on your PC. If using SkyTrak on the PC via a USB connection, your PC can remain connected to the internet via LAN or wireless.

1. To connect in Network Mode, Click the 'Device Connections' icon at the bottom of the SkyTrak app dashboard.



2. Please follow our detailed instructions in the software to connect SkyTrak in Network Mode

Troubleshooting:

I can't get my hardware to connect to the Network (middle light remains red or flashing red).

Check the network Name and Password to make sure they were entered properly (no special characters) and make sure lower/upper case have been accounted for.

To connect in network mode, SkyTrak requires a 2.4 GHz network. Also, the SkyTrak will not be compatible if your Default Gateway IP Address is set to 10.0.0.1.

I can't get my hardware to connect in the app (middle light remains solid yellow).

Make sure your network is not setup as a Guest Network. Guest Networks will not allow device-to-device communication.

If you have more than 1 network, make sure you mobile device did not automatically connect to the wrong network. The mobile device must be connected to the same network that you programmed to the unit.

The SkyTrak unit does not show up in the iPad's list of available wireless networks.

The SkyTrak may be in network mode, this is normal. You can put the SkyTrak back into Direct Mode by opening the app, letting the unit connect, and selecting 'Direct Mode' from the device connections window on the dashboard.

SkyTrak misses shots while in network mode.

Check the signal of your wireless network. You may need to add a repeater to boost the network signal.

I need help finding or changing my network password.

Due to the large number of routers out there, each with different configuration processes, we are unable to provide network support. Please contact your network professional.

Software Guide

Uploading your data to SkyGolf 360

Create a new account or log in with your existing SkyGolf 360 account

Why? When you are logged into the app, your data gets saved locally and is then synced to the cloud within our SkyGolf 360 system. If you have the Game Improvement subscription package, you can view this data at any time online by visiting skygolf360.com and logging in. If you don't have a subscription account now, don't worry! Whenever you choose to get one, all of your data will be there waiting for you.



TIP: Stay logged in. Otherwise your data will not be stored!

Main Dashboard

Here you can edit your Account Profile, get connected to the SkyTrak unit, and choose between the Practice Range or Challenges.

TIP: If you are already connected directly to your SkyTrak unit by the time you get to the dashboard, then the unit should connect on it's own within 10 seconds. The same applies if you have already set the unit up on your home network.



Menu

Accessible from the Practice Range, the Menu is where you can access alternate screens and change settings such as environmental factors, camera angles, and golfer orientation.



TIP: Access the Menu via this icon in the upper right of the Practice Range



SESSION HISTORY

a

Track all your shot data within a session.

NUMERIC DISPLAY

b

Focus on Launch Data

VIEW TUTORIAL

*Tutorials are not available in the software at this time.

SESSION SETTINGS

c

Change Settings

EXIT SESSION

Tap to Exit Practice Range

a Session History

SHOT	BALL	CLUB	LAUNCH	SIDE	BACK	SPIN	CARRY	BALL	TOTAL	
1	92	80	26.8	0.0	8946	0	21	115	2	118
2	84	81	25.2	6.1	6990	393	13	118	1	120
3	91	82	26.7	0.0	8270	-1062	27	108	3	111
4	90	80	26.2	-3.5	8851	-510	8	121	0	124
5	86	82	24.8	8.3	7191	206	14	120	1	121
6	89	87	18.1	-3.6	4234	304	-11	114	7	120
7	80	88	25.8	1.8	8861	340	1	117	3	118
8	87	86	26.0	1.7	8020	-821	-1	116	0	120
9	94	81	23.0	-0.0	8711	-880	-9	120	0	121
10	82	80	27.8	3.2	5768	-331	5	121	3	124
11	108	80	24.0	1.7	8271	-1100	-4	103	1	101
12	90	84	23.8	-5.1	8888	-817	-12	118	3	118

New Session clears all the data from the session so you can start a new session from scratch

Swipe the Profile View screen here to the LEFT to expose it. Swipe back to close it.

Tap here to close the Session History

Tapping a row highlights a row BLUE and plots the shot on the Profile View to the right

b Numeric Display



Change Club

Click here to go back to the Practice Range

TIP: Use the numeric screen when you want to focus on the data and are not concerned with seeing simulated ball flight, like at the driving range.

C Session Settings

Camera Angles

FIRST PERSON: Begins and stays in first person view

DYNAMIC: Begins in first person, transitions out to the range

FOLLOW BALL: Begins in first person and then flies along with the ball

DOWNRANGE: Begins and remains looking back from the end of the range

45 DEGREE: Begins and remains at a rear 45 degree angle.

Resets all to default



Choose between displaying tracers for current shot only, last 5 shots or all shots.

Turn on/off a center line on the range for visual reference

Turn the Range Markers ON or OFF

C Session Settings



Tap here to return to Range

Set for Right or Left Handed golfer. *You will also need to change the orientation of the unit on the mat.

Toggle between Total Distance and Carry distance as the main display in the upper left of the range.

Dispersion circles allow you to track your consistency by highlighting shot groupings on the range with each club.

Choose to display either Side Spin or Spin Axis

Change course conditions and environmental factors.

Challenge Dashboard

By selecting CHALLENGES from the main dashboard, you have the option to choose between Closest to the Pin, Target Practice and Long Drive. You will first select single or multiplayer. You can select up to 6 people to play. Next, define the dexterity or dominant hand of each player so SkyTrak knows whether to use the right or left handed laser. For lefties, simply place SkyTrak on the opposite side of the mat when prompted for that player's turn. When moving the unit for different players, make sure SkyTrak is oriented parallel to the intended target line. Next, select the number of shots per round and the distance from the flag. Each player will hit shots when prompted.



Connecting to a monitor/projector

Use a Lightning Digital AV Adapter with HDMI cable to connect to your TV.

1. Connect the adapter to your mobile device.
2. Connect the HDMI cable between the TV and the adapter.

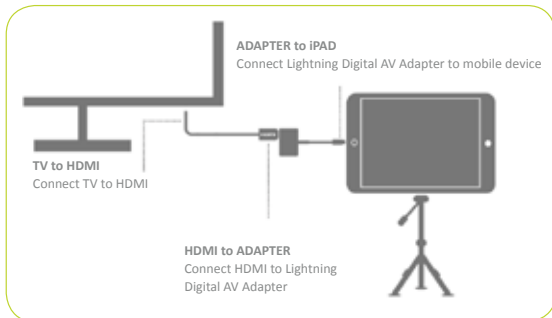

Use an HDMI cable to connect to your TV.

1. Connect the HDMI cable to your computer.
2. Connect the HDMI cable between the TV.

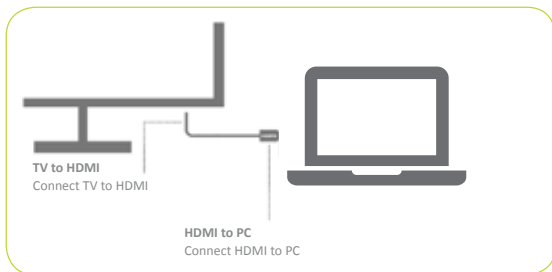

Use a Lightning Digital AV Adapter with HDMI cable to connect to your projector.

1. Connect the adapter to your mobile device.
2. Connect the HDMI cable between the projector and the adapter.

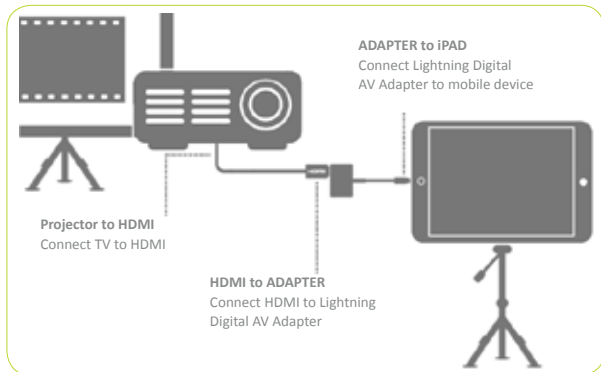

Use an HDMI cable to connect to your projector.

1. Connect the HDMI cable to your computer.
2. Connect the HDMI cable to the projector.

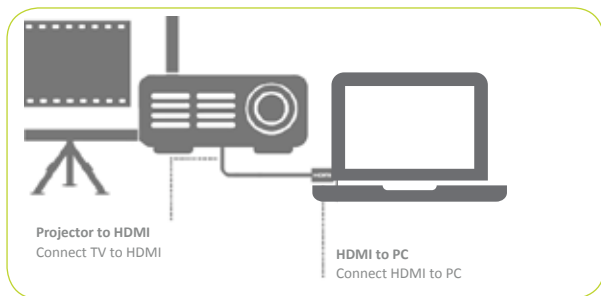

Use an Apple TV or another AirPlay- capable device.

1. On your iPad, swipe up to open the Control Center and choose AirPlay.
2. Select Apple TV and the iPad display will be mirrored on the TV.

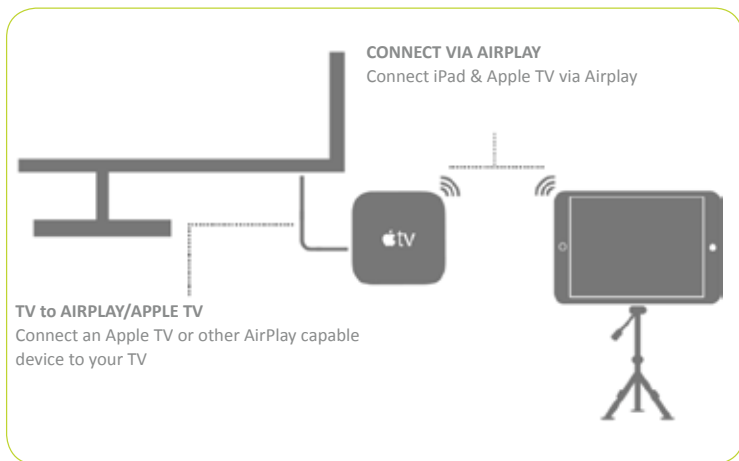

TIP: For longer sessions, plug the Lightning charger into the adapter or directly into the iPad when using AirPlay.

Notes:





Powered by:



©2017 SkyTrak, LLC. All Rights Reserved.
Patents Pending.

SkyTrak™ is a trademark owned by SkyTrak, LLC. iPad® and Apple® App StoreSM are trademarks of Apple, Inc., registered in the U.S. and other countries. Other trademarks and trade names are those of their respective owners. Use of marks not owned by SkyTrak, LLC, is under license.

All content within this Guide is copyrighted by SkyTrak, LLC and may not be reprinted without permission. The content of this Guide is furnished for informational use only, is subject to change without notice, and should not be construed as a commitment by SkyTrak, LLC. SkyTrak, LLC assumes no responsibility or liability for any errors or inaccuracies that may appear in the informational content contained in this Guide.

Updated 07-11-2017